

Dating Quaternary Deposits by Luminescence - Recent Advances

G. W. Berger

Volume 13, numéro 1, march 1986

URI : https://id.erudit.org/iderudit/geocan13_1art03

[Aller au sommaire du numéro](#)

Éditeur(s)

The Geological Association of Canada

ISSN

0315-0941 (imprimé)

1911-4850 (numérique)

[Découvrir la revue](#)

Citer cet article

Berger, G. W. (1986). Dating Quaternary Deposits by Luminescence - Recent Advances. *Geoscience Canada*, 13(1), 15-21.

Résumé de l'article

The use of thermoluminescence (TL) for dating Quaternary sediments (both heated and unheated) is expanding rapidly, and is poised to become routine for deposits previously considered barren of datable material or that are inaccessible to other absolute chrono-metric methods (e.g. ¹⁴C, K-Ar, fission-track dating). Especially significant advances in procedures, applications, understanding and technology have been made within the past few years. It is now possible to date the cooling of airfall glass in tephra, and the last exposure to light of feldspars within loess, buried soils and in some waterlaid silts. Sand-sized quartz from beach and dune deposits, and silt-sized feldspar from peats, offer potential. Perhaps outshining this substantial progress in application of TL methods to un-heated sediments is a potentially revolutionary technique, demonstrated at Simon Fraser University, that uses laser light rather than heat to stimulate the luminescent signal in minerals. This new technique is expected to be sensitive, simple and speedy. Furthermore, it has the potential to date unheated sediments that have received very brief (e.g. minutes) exposure to sunlight at deposition time.

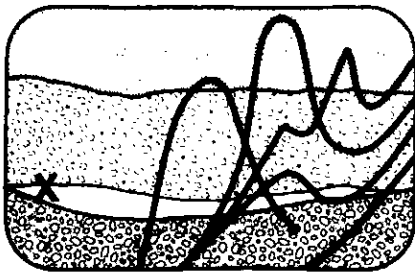

Dating Quaternary Deposits by Luminescence - Recent Advances

G.W. Berger
 Department of Physics
 Simon Fraser University
 Burnaby, British Columbia V5A 1S6

Summary

The use of thermoluminescence (TL) for dating Quaternary sediments (both heated and unheated) is expanding rapidly, and is poised to become routine for deposits previously considered barren of datable material or that are inaccessible to other absolute chronometric methods (e.g. ^{14}C , K-Ar, fission-track dating). Especially significant advances in procedures, applications, understanding and technology have been made within the past few years. It is now possible to date the cooling of airfall glass in tephra, and the last exposure to light of feldspars within loess, buried soils and in some waterlaid silts. Sand-sized quartz from beach and dune deposits, and silt-sized feldspar from peats, offer potential.

Perhaps outshining this substantial progress in application of TL methods to unheated sediments is a potentially revolutionary technique, demonstrated at Simon Fraser University, that uses laser light rather than heat to stimulate the luminescent signal in minerals. This new technique is expected to be sensitive, simple and speedy. Furthermore, it has the potential to date unheated sediments that have received very brief (e.g. minutes) exposure to sunlight at deposition time.

Introduction

The remark of Dreimanis *et al.* (1978) that "absolute dating methods beyond the radiocarbon dating range (ca. 50,000 years or 50 ka) are urgently needed, particularly in the Pleistocene stratigraphy of North America" is still appropriate today. This is especially so for Canada where Pleistocene deposits are largely glacial in origin, making regional correlations difficult at best. Recent advances in the understanding of the thermoluminescence behaviour of minerals and in

experimental procedures now permit application of thermally-stimulated luminescence (i.e. thermoluminescence or TL) to several classes of deposits previously considered barren of datable material, as well as to deposits laid down within the time window not routinely accessible by other dating methods (e.g. ^{14}C , K-Ar, fission-track dating). The useful upper limit of TL dating is probably several hundred thousand years.

Pre-1981 applications of TL to unheated Quaternary deposits have been reviewed by Dreimanis *et al.* (1978) and Wintle and Huntley (1982) who pointed out that most of the earlier work, carried out in eastern Europe and the USSR, was unreliable because of a lack of experimental rigour. Furthermore, little was then understood of the "zeroing" mechanisms of the various unheated TL mineral clocks, nor of the effects of water content and of post-depositional changes such as reworking of sediments or migration of radionuclides. The pioneering work of Wintle and Huntley (1980) on deep-sea sediments has indicated that the time of last exposure to sunlight is an event which can be dated, and has proposed methods for doing this. Much of the effort since then has attempted to understand the behaviour of TL from Quaternary minerals and to determine the major sources of error in applying these methods. Progress has been made only when material of well-known age has been studied.

Principles of TL Dating

The luminescence emitted from a mineral heated in the laboratory is proportional to the number of electrons stored in *traps* (particular kinds of impurities or crystal defects). These electrons migrate to traps upon absorption by the crystal of energy from natural past ionizing radiations, mainly α , β and γ . The number of electrons in the traps is, therefore, a measure of the past ionizing radiation dose (*paleodose*), hence, of the time elapsed since the last event which emptied all the traps. In principle then, a TL apparent age involves two separate experiments: measurement of the luminescence and determination of the past dose rate. The luminescence sensitivity to ionizing radiation is measured at the same time as the natural luminescence signal. Simply,

$$\text{TL apparent age} = \text{paleodose/dose rate.}$$

The emphasis of this review will be on progress in attaining accurate measurement of the part of the luminescence which represents the post-depositional dose. Difficulty in the accurate determination of this component of the age equation has been the principal stumbling block to successful application of TL dating techniques to sediments. Details of the principles and practices for determination of the dose rate have been well reviewed elsewhere (Mejdahl and Wintle, 1984; Aitken, 1985).

Essentially, two classes of events are dat-

able: (1) growth of a mineral or its last cooling, and (2) the last exposure to sunlight. The effect of the agents of heat and light is portrayed in Figure 1 where, within the representational energy level diagram for a hypothetical crystal, electrons are dislodged from traps and migrate through the lattice conduction band. Some of these freed electrons recombine with an opposite charge (positive holes) at luminescence centres (e.g. trace impurities) to emit a photon of light.

The cardinal difference between these two detrapping processes is that after heating no further thermoluminescence can be measured, whereas after exposure to light some electrons still remain in traps, the number of these residual electrons being a function of the duration of light exposure, wavelength of incident light (photon energy), thermal activation energy of the traps ("depth" below the conduction band), and mineral type. It is this complicated dependency of the residual TL at deposition time that has, more than any other single aspect, hindered progress in accurate dating of unheated sediments.

In practice,

$$\text{TL apparent age} = \frac{\text{equivalent dose}}{\text{effective dose rate}}$$

where the equivalent dose (ED) is the laboratory β or γ dose that produces the same TL intensity as the paleodose (arising from α , β and γ radiations). This equivalent dose is less than the paleodose because α particles are only about 10% as effective as γ or β rays in producing TL. In separate experiments the effective dose rate is determined from measurements of U, Th and K concentrations — the component calculated for the α radiations being less than the actual α dose rate, because of the aforementioned low ef-

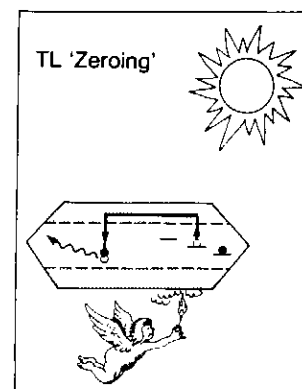

Figure 1 A cartoon depicting the "zeroing" of a TL mineral clock by heat or light. Within the hypothetical crystal is a representation of an energy level diagram. Energy from natural ionizing radiation is carried by electrons from the lattice valence band (lower), through the conduction band (upper), and may be stored finally in electron traps (e.g. defects), at different levels below the conduction band. Heat or light can remove many of these electrons (as shown), some of which emit light upon recombining with opposite charges at luminescence centres (e.g. trace impurities).

efficiency of α particles in producing TL. In addition to the α , β and γ components of the dose rate, there is a normally small cosmic ray contribution, which can be estimated readily from the data of Prescott and Stephan (1982).

As the median ranges of α , β and γ radiations in sediments are about 20 μm , 2 mm and 30 cm respectively, the choice of sample grain sizes is crucial to accurate determination of the equivalent dose (e.g. Aitken, 1985). Consequently, either 2-10 μm grains (for which α attenuation is slight) or 100-300 μm grains (for which the effects of external α dose can be removed by acid etching) are used.

The procedures for measuring the equivalent dose differ substantially for heated and unheated material. For the former the additive-dose technique developed for pottery dating (Aitken, 1985) is appropriate; for the latter the partial bleach (R-1') and regeneration techniques introduced by Wintle and Huntley (1980) are required. Singhvi *et al.* (1982) proposed a special case of the partial bleach technique, hereafter called the total bleach method. All three methods attempt to deal with the presence of a non-zero TL component at deposition time. Basically, the partial bleach method permits arbitrarily short laboratory light exposures to be used to evaluate the equivalent dose, whereas the other two methods use long light exposures. Because of their relative ease of use, the regeneration and total bleach techniques may be preferred for sediments — such as some loessic silt — that have received long light exposures at deposition time. Low residual TL signals, expected from such long exposures, are necessary for all three methods to give the correct age. Nevertheless, as will be discussed below, intensive insolation is no guarantee of a low TL signal at deposition time. In principle, only the partial bleach technique can yield the correct age when the residual TL signal is not relatively low.

Two of the major difficulties in determining accurate TL apparent ages of geological material have been uncertainty in the extent of "zeroing" of the TL at deposition time (unheated material only), and the presence of a type of TL instability known as anomalous fading. Recent efforts to understand and control these factors will be discussed before summarizing applications of TL dating to geological material.

"Zeroing" of the TL at Deposition Time

The assumption that a TL mineral clock has been effectively reset or "zeroed" at deposition time has been tested directly for some sediments by measuring the equivalent doses for zero-age material. Such tests have been made for some unheated sediments: suspended river silts, surface soils, a peat bog, and the upper few millimetres of dune deposits. These studies, discussed below, clearly

illustrate how readily one can overestimate TL apparent ages by "overbleaching" the samples during laboratory light exposures.

Dune deposits provide a good example of material thought to have been exposed extensively to sunlight before final burial. Yet studies show that the TL has not always been well "zeroed". On the one hand, the assumption that intensive insolation has reduced the TL to a very low (residual) level seems to have been confirmed by the measurement of low equivalent dose (1.5 ± 1.0 Gy) (Gray (Gy) is the official SI unit of dose ~ 100 rads) for ca. 100 μm quartz from the top one millimetre of one dune (Singhvi *et al.*, 1983), when the total bleach method was used. On the other hand, for ca. 100 μm quartz grains extracted from the surfaces of other dune deposits, Prescott (1983) and Readhead (1984) observed that a TL signal remained which, surprisingly, could easily be diminished further by additional light exposure (both natural and artificial). Huntley (1985) inferred that such quartz has received effectively only a short light exposure, and that zero equivalent dose values can be measured only by using the partial bleach technique with short light exposures. Use of light exposures longer than effectively received by the sample at deposition time will detract electrons that were not disturbed at deposition time, producing over-estimates of the equivalent dose as shown in Figure 2. The effect of this overbleaching for older samples can be seen by shifting the TL axis to the right in Figure 2.

Another way by which overbleaching can occur is to use higher photon energies (shorter wavelengths) than were experienced by the sample at deposition time (Berger and Huntley, 1982; Huntley *et al.*, 1983; Berger *et al.*, 1984; Berger, 1984, 1985a; Huntley, 1985). As explained below, shorter wavelengths can be selectively blocked in transmission through cloudy water. For example, Berger *et al.* (1984) observed that the TL apparent age for a marine core-top was more than twice the expected date of 1.5 ka unless wavelengths below ca. 550 nm (yellow) were blocked from the laboratory light source. Also, Huntley (1985) showed that the measured equivalent doses for several suspended river silts could be reduced to near zero ($<5 (\pm 2-7)$ Gy) values if wavelengths up to ca. 550 nm were blocked. Using the partial bleach technique with wavelengths up to ~ 360 nm (UV) blocked, Huntley (1985) measured an equivalent dose of <1 Gy for the A horizon of a surface soil.

In summary, these experiments have shown that: (1) the TL from 100 μm quartz grains from intensively insolated dune deposits is not always reduced to a very low level at deposition time, and (2) for water-lain silts the TL apparent age will generally depend upon the spectrum of the laboratory light exposure. How can we understand these ob-

servations? The explanation probably hinges upon an observed wavelength dependency of the reduction in TL from feldspars and quartz, together with the known behaviour of light in turbid water.

Firstly, Berger (1985a) noticed that for quartz the TL was relatively insensitive to visible wavelengths >450 nm (indigo) (Figure 3). This suggests that for many intensively insolated beach and dune deposits some factor attenuates the shorter wavelengths before they penetrate the 100 μm quartz grains. One such factor could be natural surface coatings on these grains (any such coatings are routinely removed before TL analyses).

Regarding the second point, there is a natural mechanism which alters the light spectrum experienced by waterborne minerals — absorption and scattering effects of *solid* particles (e.g. Jerlov, 1976). In particular, in cloudy or turbid water the solar spectrum appears shifted toward the red by selective removal of the shorter wavelengths. Thus the TL of most waterborne quartz would not likely be reduced sufficiently at deposition time for present TL methods of dating to be successful. On the other hand, the TL of feldspars (which dominate the TL from most polymineralic sediments (Berger and Huntley, 1982; Wintle, 1982; Berger, 1984)) is readily reduced by all visible wavelengths (Kronborg, 1983; Berger, 1985a), though the longer wavelength light is less effective than the shorter wavelengths in draining this TL. Consequently, for dating water-lain deposits it is prudent to use only feldspars, and to employ only long wavelengths (e.g. >550 nm) and the partial bleach technique, because most of the shorter wavelengths will have been attenuated in turbid water.

The effectiveness of resetting of the TL in large (>100 μm) grains of quartz and feldspar deposited by water has not yet been adequately investigated, though some workers (discussed below) have attempted to use such grains to date water-lain sediments. The implication of the above studies on silts is that only the feldspars may serve as suitable TL clocks; however, it is hard to imagine large grains of these being in suspension long enough to have been more than slightly bleached.

Anomalous Fading

Another factor which can drastically affect the accuracy of the equivalent dose measurement is anomalous fading. Its effect is to produce an underestimate of the correct age. Anomalous fading is the type of TL instability observed by Wintle (1973, 1977) in volcanic feldspars and is generally attributed to a quantum mechanical tunnelling of electrons out of their traps. It cannot be described by the usual kinetics theory and affects all regions of the glow curves equally. Its presence, however, can be detected by laboratory storage tests on artificially irradiated

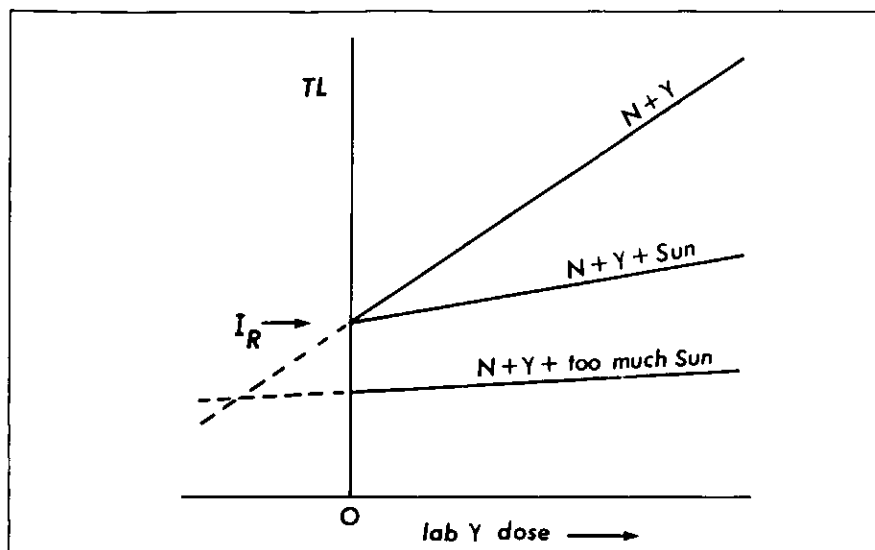

Figure 2 An idealized illustration of the partial bleach or R-I method for measuring equivalent doses in unheated sediments. Here the sample is of zero age. The upper line is the usual additive-dose TL build-up curve one would construct (and extrapolate to zero TL) for heated material. The topmost lower curve represents subsamples given a short laboratory light exposure. If this light exposure is less than that experienced by the sample at deposition time, the additional laboratory exposure will not reduce the TL of the unirradiated sample significantly below the residual intensity (I_R) remaining at deposition time, but will reduce that of the laboratory irradiated subsamples; the resulting intersection is on the zero dose axis. On the other hand, an excessive laboratory light exposure will "overbleach" the subsamples, producing an equivalent dose which is too large (after Huntley, 1985).

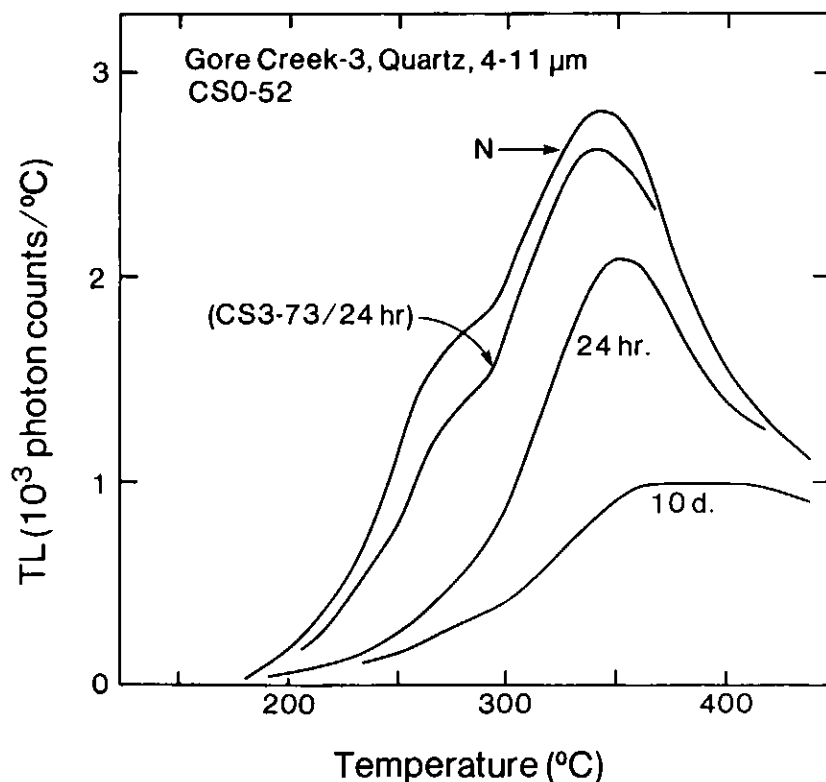

Figure 3 Glow curves for unirradiated fine-grained quartz (N) exposed to a Hg-based "sunlamp" for different lengths of time and with different parts of the spectrum blocked. The two curves, 24 hours and 10 days, were obtained when wavelengths below ~360 nm (UV) were blocked (filter CSO-52). One curve represents a 24-hour exposure when wavelengths below ~420 nm (violet) (CS3-73) were blocked. A 14-day exposure with wavelengths below ~550 nm (yellow) blocked (not shown) left the N curve unchanged (after Berger, 1985a).

samples. Typically, the laboratory-induced TL intensity of a sample exhibiting anomalous fading will decrease by several percent or more within a few weeks of irradiation.

Generally, quartz does not exhibit anomalous fading, and whenever fading is observed in polymineralic sediments it is attributed to the feldspars, which usually dominate the TL. Because a variety of non-volcanic feldspar types can be expected in sediments, when fading is observed it is not known whether it is due to a few grains that fade strongly or to a fading component common to all of the feldspar grains in that particular sample.

Two approaches to this problem have been tried: isolation of a non-fading mineral, and exploitation of the TL behaviour of the fading minerals. For the first purpose, quartz is commonly extracted from both coarse-grained (Aitken, 1985) and fine-grained material (Wintle, 1982; Lamothe, 1984; Berger, 1984). Nevertheless, quartz presents two problems of its own — not only inefficient resetting of the TL at deposition time (discussed above), but also onset of non-linearity in TL build-up curves at relatively low doses. Recently, the fine-grained magnetic fraction of polymineralic silts has been discovered to exhibit little or no anomalous fading (Berger, 1984), potentially providing a useful antidote to the problem. For tephra, Berger (1985b) has shown that the glass component exhibits no fading and so can be used to circumvent the ill effects of fading observed in the bulk fractions of such material.

Exploitation of the TL behaviour of the fading minerals has also recently been apparently successful. Berger (1984) and Lamothe (1984) have demonstrated that acceptable TL ages can be obtained if the TL readout is delayed several weeks or months after laboratory irradiations to permit any minor or short-term fading component to decay. For zircons extracted from zircon sands, Templer (1985) has shown that the decay of any short-term fading component can be accelerated selectively by storage at suitably chosen elevated temperatures. Such a procedure holds great promise for polymineralic feldspar-dominant samples that contain no volcanic feldspars, or perhaps only a minuscule fraction of them. For volcanic feldspars, however, neither the delayed-glow approach (Berger, 1985b) nor the use of elevated temperatures (Wintle, 1977) seems to eliminate the fading component in practicable time intervals. Templer (1985) has also observed that long wavelength light (e.g. >600 nm) can accelerate the short-term fading component in zircons, but this technique is unlikely to be useful for feldspars, the stable TL of which is known to be sensitive to all visible wavelengths (unlike zircons).

Another way to exploit the TL behaviour of the fading minerals has recently been implied by the work of Akber and Prescott (1985).

They have suggested that strong anomalous fading is associated with the Ca-rich feldspars, and have begun a study of the TL emission spectra of plagioclase containing different proportions of Na and Ca. They observed a trend in TL sensitivity and emission spectra which parallels the trend in fading behaviour. The implication of their observations is that by recording only the longer wavelength emissions (ca. 550 nm) during the readout, one may be able to selectively block the signals from the strongly fading feldspars, which emit little or no light in that wavelength region — a very promising approach.

Applications to Tephra

In this review the only Class 1 ("growth of a mineral or its last heating") application to be discussed will be the dating of tephra. Applications to other heating events are summarized elsewhere (Aitken, 1985). As the TL of the primary constituents in volcanic ash is expected to be zeroed by heat immediately before deposition, the TL additive-dose technique which was developed for pottery dating can be applied.

Tephra deposits frequently provide a pronounced time-stratigraphic marker horizon, yet, within the time window ~50-300 ka, cannot be accurately and directly dated, unless they are near their source. For proximal material, coarse-grained sanidine can sometimes be extracted for accurate K-Ar dating of deposits as young as ~100 ka (e.g. Naeser *et al.*, 1981). For both proximal and distal tephra >200 ka old, fission-track dating can be used, though it is very imprecise for deposits up to ~500 ka old if only glass is available. Furthermore, glass usually provides only a minimum date, due to track annealing.

In studies of several well-characterized North American tephra, Berger and Huntley (1983) and Berger (1985b) demonstrated that the 4-10 μm -sized airfall glass provides a new absolute clock for dating the deposition of such material. This glass is often homogeneous and transparent, has good TL sensitivity and exhibits insignificant anomalous fading. The glow curves for some well-known Holocene tephra are shown in Figure 4. Of these, only the Mazama and St. Helens Wn samples were accurately dated by TL; Berger (1985b) has discussed why the technique might better be applied to older deposits.

For older tephra, the main limitation to accuracy appears to be anomalous fading associated with the presence of feldspars. Preliminary experiments by the author have shown that such anomalous fading can be eliminated by isolation of the 4-10 μm -sized glass from crystals, with the use of heavy liquid separation procedures.

Applications to Unheated Sediments

Attempts have been made to date the last exposure to sunlight of several types of unheated sediments: beach and dune sands,

loessic silts, water-lain silts and sands, buried soils, peat and a lodgment till. Only those applications on independently dated material, or applications extending original studies on such material, will be discussed here. For this reason I shall bypass beach and dune sands; rigorous studies have only just begun (see discussion of "zeroing" above). Efforts by Singhvi *et al.* (1982, 1983) and Hutton *et al.* (1984) have produced reasonable TL apparent ages for such sands, but it is difficult to assess their accuracy in view of the paucity or absence of independently known deposition ages.

The techniques proposed by Wintle and Huntley (1980) have been extensively applied to loessic silts. For the polymineralic (feldspar-dominated) fine (<10 μm) grains, Wintle (1981, 1982), Wintle and Brunnacker (1982) and Wintle *et al.* (1984) have obtained satisfactory TL ages up to ~40 ka using the partial bleach technique, while Proszynska (1983) and Wintle *et al.* (1984) report acceptable ages up to ~100 ka with the regeneration method. Though Wintle (1981, 1982) obtained reasonable dates, no independently measured ages were compared. Generally, the sensitivity of feldspar TL to light and the intensive insolation of such material have permitted uncomplicated application of the regeneration technique, and allowed spectral sensitivity effects to be ignored. These authors have not used the partial bleach technique for silts older than ~40 ka because of observed non-linear TL growth curves. One interesting result of these studies has been the observation of Wintle *et al.* (1984) that loess deposition at a Normandy site was rapid and occupied only about

10% of the sampled time interval (~10-120 ka). Norton and Bradford (1985) report several TL apparent ages obtained by the partial bleach technique for loess from Iowa having associated radiocarbon dates of 14,000-30,000 years B.P. Though there are several good agreements, two TL ages are significantly low, while four are excessively high; no satisfying explanation is given for these discrepancies.

Recently a serious problem has been encountered with European loess older than ~100 ka, for Wintle (1985) and Debenham (1985) have been unable to obtain apparent ages (using the regeneration technique) beyond ~120 ka with silts up to ~700 ka in age. At present this issue is unresolved, but the possibility that uncorrected sensitivity changes invalidated the regeneration technique needs to be tested. Large sensitivity changes can occur with the use of the regeneration technique (Rendell *et al.*, 1983). Preliminary results for some North American loess (Johnson *et al.*, 1985) seem to confirm that such sensitivity changes are significant. Additionally, the partial bleach technique should be applied to the problematical European samples. An alternative is to utilize only the fine grains of quartz, though they have some undesirable properties, as discussed above.

Much progress has been made in the TL dating of fine-grained water-lain sediments through several detailed studies of known age material. For example, Berger *et al.* (1984) and Berger (1984, 1985a) have shown that for such material, quartz TL was ineffectively "zeroed" (see above discussion) whereas feldspars were very sensitive to light. Furthermore, of the present techniques, only the

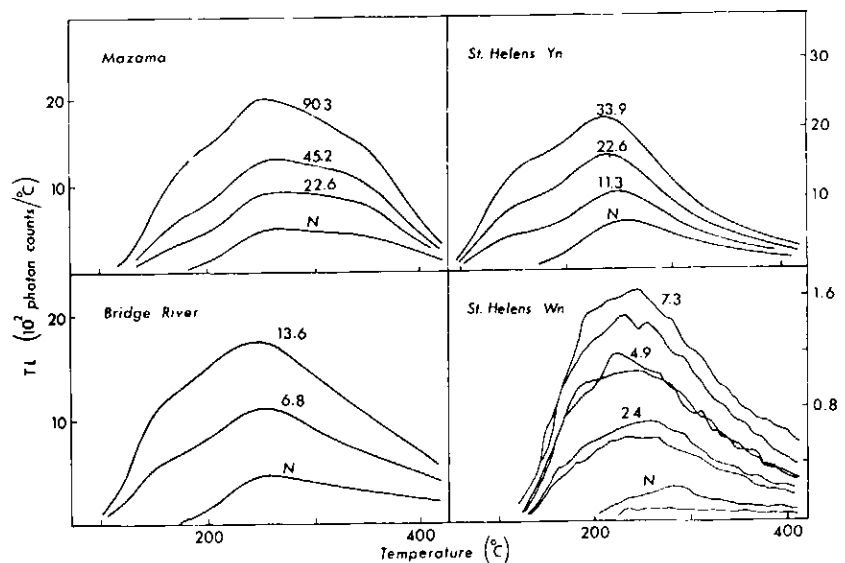

Figure 4 Additive-dose glow curves for four well-known Holocene tephra deposits. Different γ doses (in Grays, the SI unit of dose) have been added to unirradiated (N) samples of bulk 4-11 μm grains. The accepted (corrected radiocarbon) deposition ages are: 7.4-8.0 ka (Mazama), 3.7 ka (St. Helens Yn), 1.9 or 2.5 ka (Bridge River), and A.D. 1480 (St. Helens Wn). For two of these, acceptable TL apparent ages were measured — 7.8 \pm 0.5 ka for Mazama and 480 \pm 50 yr for Wn — partly because for only these were the 4-11 μm grains almost 100% glass.

partial bleach technique with long wavelengths of light (namely >550 nm) was reliable. Moreover, the partial bleach technique was able to measure the equivalent dose accurately only for fine-grained feldspars deposited at rates of about 5 mm/year or less (e.g. Figure 5); at rates above ~ 10 cm/year the feldspar TL was not reset sufficiently for this technique to be successful (Berger, 1985a, c). These conclusions about the limitations imposed by deposition rate must be qualified. The 0.5 cm and 10 cm varves of these studies represent deposition over a probable interval of 4-5 months, rather than one year, and even a rate of 24 cm/year implies about 30 $\mu\text{m}/\text{hour}$ — sufficiently slow, it would seem, for the TL of 5-10 μm feldspar grains to be significantly reduced. The implication is that for the ~ 10 cm silt band studied by Berger, some sedimentation process has contrived to shield the fine-grained feldspars from light. Several processes — such as flocculation, interflows and underflows — have been suggested (Berger, 1985a, c). Thin clay bands, however, are datable.

The above wavelength dependency of measured equivalent doses helps to explain the unexpectedly high TL apparent ages obtained for two fine-grained feldspar-dominated samples by Bryant *et al.* (1983), and for one such sample of zero age by Belperio *et al.* (1984).

For a fine-grained lodgment till, Berger (1984) was unable to obtain an accurate TL age, and concluded that this till had been exposed to little or no light at deposition time. The implication is that such tills cannot be dated by techniques which exploit the light sensitivity of electron traps.

Some workers have applied the regeneration technique to 100-300 μm feldspar grains extracted from water-lain silts and sands (Kronborg, 1983; Mejdahl *et al.*, 1984). Though they obtained TL apparent ages up to ~ 300 ka, often in reasonable agreement with expected deposition ages, some of these agreements could be fortuitous because neither anomalous fading (which can lower apparent ages) nor the effects of laboratory optical bleaching conditions (which can raise apparent ages) were discussed. Furthermore, rigorous study of the effectiveness of "zeroing" of the TL of such large grains in water-lain sediments has not yet been attempted, unlike for silt-sized material.

Large quartz grains (~ 100 μm) from coastal marine sediments have been analyzed by Belperio *et al.* (1984) in a comparative study with the radiocarbon and amino acid techniques. The quartz yielded excessive TL apparent ages for three samples, but reasonable apparent ages for two others. Interpretation was hampered by a complicated sample history; some samples existed possibly as an eolian blanket on the gulf floor before marine inundation, while others were probably redeposited by bottom currents from older material of uncertain genesis.

The chronostratigraphic and paleoclimatic importance of many buried soils and peats, as well as the absence of direct dating techniques for them beyond ~ 50 ka, are strong incentives for the development of reliable TL procedures for dating their deposition ages. In these deposits the useful TL clocks are the detrital feldspars. Several studies (Berger and Huntley, 1982; Divigalpitiya, 1982; Huntley *et al.* 1983; Huntley, 1985) have shown the fine silt grains from peat and the A horizons of soils to be datable with the partial bleach technique. Generally, correction to the dose rate calculations for attenuation of radiation by the high organic content must be made (Divigalpitiya, 1982), in a fashion similar to the correction for water content (e.g. Wintle and Huntley, 1980). As well, only the partial bleach technique should be used, with long wavelengths of light, though Huntley (1985) reported success for one sample (HaRk-1) for which wavelengths as short as ~ 360 nm were employed. Two serious problems remain: how to correct for expected past changes in water content in peats (due to compaction), and for past changes in U concentration (due to enrichment by complexing on organics). Notwithstanding these potential limitations, a realistic minimum TL age of 480 ± 90 ka (the sample showed uncorrected anomalous fading) was calculated by Divigalpitiya (1982; see also Huntley *et al.*, 1983) for a thick peat layer having an enriched radiocarbon date of ~ 72 ka. This sample was about one metre above a tephra layer having a zircon fission-track age of 840 ± 210 ka (Easterbrook *et al.*, 1981).

Other workers (Kronborg, 1983; Wintle *et*

al., 1984; Wintle and Catt, 1985) have also reported TL ages for soils. Kronborg used the 100-30 μm feldspar grains and the total bleach technique, but did not consider anomalous fading nor laboratory optical bleaching effects. Wintle and co-workers, using the fine-grain regeneration technique with a UV component, reported reasonable TL ages for two soils developed on loess, though firm independent age estimates were lacking. In the study of Wintle and Catt (1985), however, the burial time of one horizon was known ($\sim 5-6$ ka); the associated TL age of 4.6 ± 0.4 ka is in reasonable agreement.

All of these studies demonstrate that buried soils and peats are very promising materials for TL dating, but the "zeroing" processes are not understood. It has been suggested that the mineral grains in A horizon material are exposed to light while they are turned over during bioturbation (Huntley *et al.*, 1983). Whether that mechanism dominates is unknown; very likely eolian silts are added during the soil formation process. For peats, mineral grains can be added to the deposit by wind or water. The potential of B horizon material in soils for TL dating has not yet been adequately investigated. Wintle and Catt (1985) observed apparent-age reversals in a profile of B subhorizons. The possibility that these reversals are experimental artifacts (overbleaching) needs testing.

Dating Unheated Sediments with Lasers

An exciting new technology for dating unheated sediments has recently been demonstrated at Simon Fraser University (Huntley *et al.*, 1985). Rather than detrapping electrons

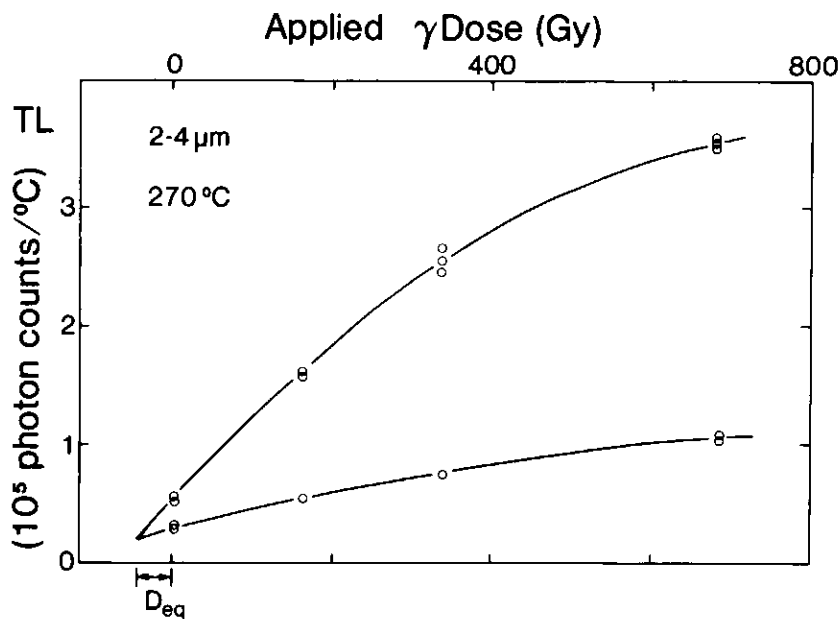

Figure 5 The measurement of equivalent dose (D_{eq}) by the partial bleach technique for the 2-4 μm polymineralic grains (feldspar dominated) from a thin winter varve of a glaciolacustrine deposit. From the plateau of D_{eq} values for the glow-curve temperature interval 260-320°C, a TL apparent age of 14 ± 2 ka was calculated (after Berger, 1985c).

thermally (TL), this has been done optically (Figure 6). The instant the argon ion laser was switched on, an intense luminescence signal was observed which decayed rapidly, and non-exponentially. Two remarkable features of this optically-stimulated luminescence (OSL) technique are its sensitivity and ease of use. Extremely light-sensitive electron traps are directly sampled; in one experiment ~90% of them corresponded to about 10 seconds of unattenuated sunlight exposure, implying that samples with as little as ~30 seconds of light exposure may be datable.

The implication of this behaviour is that this technique can measure deposition ages for very rapidly deposited sediments, whereas the conventional partial bleach technique (e.g. Figure 5) is apparently restricted to material deposited at less than a centimetre per year. The OSL technique may also permit the use of quartz for dating water-lain silts if the proper laser wavelength is chosen. Even without these possible benefits, the optical technique is potentially revolutionary because it may permit rapid and automated sample analysis.

Concluding Remarks

The past few years have brought several important advances to the dating of Quaternary deposits by luminescence: a new application of the TL technique developed for pottery dating, new understanding of the TL behaviour of minerals, refined procedures to control some of the major sources of error, and a new technology (using lasers) for dating unheated sediments.

It is now feasible to date the deposition age of tephra by utilizing the glass component with the additive dose technique originally developed for pottery dating. For unheated sediments such as loess, lacustrine silts, buried soils and peats, the last exposure to sunlight can be dated provided attention is paid to laboratory bleaching conditions, mineral type, and the proper fitting of curves to TL build-up data (Berger and Lockhart, 1986). The new use of laser light to directly sample the most light-sensitive electron traps within unheated minerals may displace the current use of thermally stimulated luminescence (TL) and thereby revolutionize the dating of unheated sediments.

Nevertheless, several problems remain. Additional and more firmly grounded techniques are needed to circumvent the perennial problem of anomalous fading in some feldspars. Work in progress may provide such techniques. A demonstration of the useful upper age limit of TL dating has not yet been given for several types of sediment. Potentially this limit is several hundred thousand years, but could be greater for some, as yet untried, minerals. Present pessimism about the use of feldspars and quartz beyond 100-200 ka needs to be dealt with. Finally, little has been said here about problems in dose-rate calculations, but it is clear that for peats

and coarse-grained deposits such as beach and dune sands, the dose rate could easily vary with time. Work in progress may demonstrate means to cope with this problem.

Acknowledgements

I wish to thank Prof. D.J. Huntley, J.J. Kirkey and two reviewers for critically reading a version of this manuscript, and J.C. Holden for his contribution to Figure 1.

References

- Aitken, M.J., 1985, Thermoluminescence dating, Academic Press, New York, 351 p.
 Akber, R.A. and Prescott, J.R., 1985, Thermoluminescence in some feldspars - early results from studies of spectra: Nuclear Tracks, v. 10, (in press).
 Belperio, A.P., Smith, B.W., Polach, H.A., Nittrouer, C.A., DeMaster, D.J., Prescott, J.R., Hails, J.R. and Gastin, V.A., 1984, Chronological studies of the Quaternary marine sediments of northern Spencer Gulf, South Australia: Marine Geology, v. 61, p. 265-296.

- Berger, G.W., 1984, Thermoluminescence dating studies of glacial silts from Ontario: Canadian Journal of Earth Sciences, v. 21, p. 1393-1399.
 Berger, G.W., 1985a, Thermoluminescence dating studies of rapidly deposited silts from south-central British Columbia: Canadian Journal of Earth Sciences, v. 22, p. 704-710.
 Berger, G.W., 1985b, Thermoluminescence dating of volcanic ash: Journal of Volcanology and Geothermal Research, v. 25, p. 333-347.
 Berger, G.W., 1985c, Thermoluminescence dating applied to a thin winter varve of the late glacial South Thompson silt, south-central British Columbia: Canadian Journal of Earth Sciences, v. 22, p. 1736-1739.
 Berger, G.W. and Huntley, D.J., 1982, Thermoluminescence dating of terrigenous sediments: PACT Journal, Council of Europe, v. 6, p. 495-504.
 Berger, G.W. and Huntley, D.J., 1983, Dating volcanic ash by thermoluminescence: PACT Journal, Council of Europe, v. 9, p. 581-592.
 Berger, G.W., Huntley, D.J. and Stipp, J.J., 1984, Thermoluminescence studies on a ^{14}C -dated marine core: Canadian Journal of Earth Sciences, v. 21, p. 1145-1150.

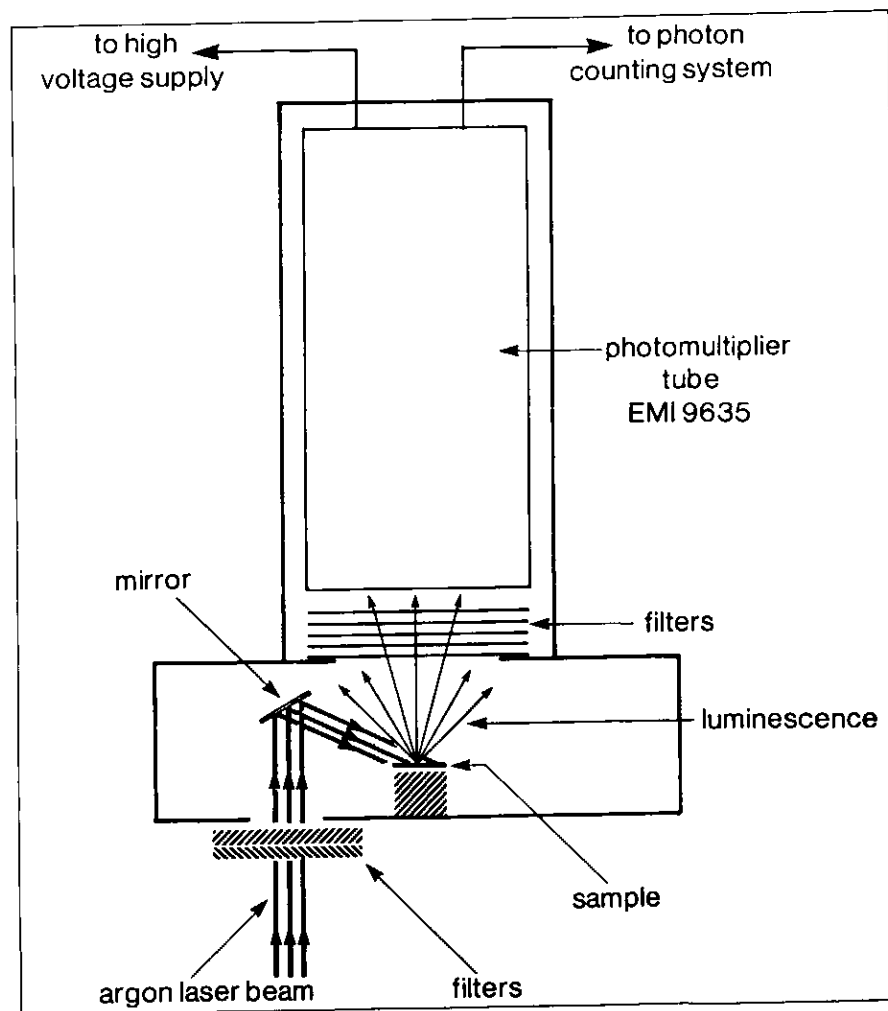

Figure 6 Schematic of the apparatus used by Huntley et al. (1985) to measure the luminescence stimulated in a geological sample by the 514.5 nm beam from an argon ion laser. With this optical technique, only the most light-sensitive electron traps are sampled. The measurement of this luminescence is analogous to a direct high precision measurement of the difference between the two curves in Figure 5 (reprinted by permission from Nature, v. 313, p. 105-107, © 1985 Macmillan Journals Limited).

- Berger, G.W. and Lockhart, R.A., 1986, Regression and error analysis applied to the dose response curves in thermoluminescence dating: *Journal of Mathematical Geology*, (submitted).
- Bryant, I.D., Gibbard, P.L., Holyoak, D.T., Switsur, V.R. and Wintle, A.G., 1983, Stratigraphy and palaeontology of Pleistocene cold-stage deposits at Alton Road Quarry, Farnham, Surrey, England: *Geological Magazine*, v. 120, p. 587-606.
- Debenham, N.C., 1985, Use of UV emissions in TL dating of sediments: *Nuclear Tracks*, v. 10, (in press).
- Divigalpitaya, W.M.R., 1982, Thermoluminescence dating of sediments: unpublished M.Sc. thesis, Simon Fraser University, Burnaby, British Columbia, 93 p.
- Dreimanis, A., Hütt, G., Raukas, A. and Whippley, P.W., 1978, Dating methods of Pleistocene deposits and their problems – 1. Thermoluminescence dating: *Geoscience Canada*, v. 5, p. 55-60.
- Easterbrook, D.J., Briggs, N.D., Westgate, J.A. and Gorton, P., 1981, Age of the Salmon Springs glaciation in Washington: *Geology*, v. 9, p. 87-93.
- Huntley, D.J., 1985, On the zeroing of the thermoluminescence of sediments: *Physics and Chemistry of Minerals*, v. 12, p. 122-127.
- Huntley, D.J., Berger, G.W., Divigalpitaya, W.M.R. and Brown, T.A., 1983, Thermoluminescence dating of sediments: *PACT Journal*, Council of Europe, v. 9, p. 607-618.
- Huntley, D.J., Godfrey-Smith, D.I. and Thewalt, M.L.W., 1985, Optical dating of sediments: *Nature*, v. 313, p. 105-107.
- Hutton, J.T., Prescott, J.R. and Twidale, C.R., 1984, Thermoluminescence dating of coastal dune sand related to a higher stand of Lake Woods, Northern Territory: *Australian Journal of Soil Science*, v. 22, p. 15-21.
- Jerlov, N.G., 1976, *Marine optics*, Second Edition, Elsevier Scientific Publishing Company, New York, 231 p.
- Johnson, R.J., Stipp, J.J., Wintle, A.G. and Tamers, M.A., 1985, Thermoluminescence dating of sediments: A re-extension of age range of loess: *Geological Society of America, Abstracts with Programs*, v. 17, p. 620.
- Kronborg, C., 1983, Preliminary results of age determination by TL of interglacial and interstadial sediments: *PACT Journal*, Council of Europe, v. 9, p. 595-606.
- Lamothe, M., 1984, Apparent thermoluminescence ages of St. Pierre sediments at Pierreville, Quebec, and the problem of anomalous fading: *Canadian Journal of Earth Sciences*, v. 21, p. 1406-1409.
- Mejdahl, V., Kronborg, C. and Strickertsson, K., 1984, TL dating of Scandinavian Quaternary sediments, in *Proceedings national symposium on thermally stimulated luminescence and related phenomena*, Ahmedabad, India: Physical Research Laboratory, p. R46-R51.
- Mejdahl, V. and Wintle, A.G., 1984, Applications to archaeological and geological dating, in Horowitz, Y.S., ed., *Thermoluminescence and thermoluminescent dosimetry*: CRC Press, Boca Raton, p. 133-190.
- Naeser, C.W., Briggs, N.D., Obradovich, J.D. and Izett, G.A., 1981, Geochronology of Quaternary tephra deposits, in Self, S. and Sparks, R.S.J., eds., *Tephra studies*: D. Reidel, Boston, p. 13-47.
- Norton, L.D. and Bradford, J.M., 1985, Thermoluminescence dating of loess from western Iowa: *Soil Science Society of America Journal*, v. 49, p. 708-712.
- Prescott, J.R., 1983, Thermoluminescence dating of sand dunes at Roonka, South Australia: *PACT Journal*, Council of Europe, v. 9, p. 505-512.
- Prescott, J.R. and Stephan, L.G., 1982, The contribution of cosmic radiation to the environmental dose for thermoluminescence dating – latitude, altitude and depth dependences: *PACT Journal*, Council of Europe, v. 6, p. 17-25.
- Proszynska, H., 1983, TL dating of some subaerial sediments from Poland: *PACT Journal*, Council of Europe, v. 9, p. 539-546.
- Readhead, M.L., 1984, Thermoluminescence dating of some Australian sedimentary deposits: unpublished Ph.D. thesis, Australian National University, Canberra, 696 p.
- Rendell, H.M., Gamble, I.J.A. and Townsend, P.D., 1983, Thermoluminescence dating of loess from Potwar Plateau, northern Pakistan: *PACT Journal*, Council of Europe, v. 9, p. 555-562.
- Singhvi, A.K., Sharma, Y.P. and Agrawal, D.P., 1982, Thermoluminescence dating of sand dunes in Rajasthan, India: *Nature*, v. 295, p. 313-315.
- Singhvi, A.K., Sharma, Y.P. and Agrawal, D.P. and Dhir, R.P., 1983, Thermoluminescence dating of dune sands – some refinements: *PACT Journal*, Council of Europe, v. 9, p. 498-504.
- Templer, R.H., 1985, The removal of anomalous fading in zircon: *Nuclear Tracks*, v. 10, (in press).
- Wintle, A.G., 1973, Anomalous fading of thermoluminescence in mineral samples: *Nature*, v. 245, p. 143-144.
- Wintle, A.G., 1977, Detailed study of a thermoluminescent mineral exhibiting anomalous fading: *Journal of Luminescence*, v. 15, p. 385-393.
- Wintle, A.G., 1981, Thermoluminescence dating of late Devensian loesses in southern England: *Nature*, v. 289, p. 479-480.
- Wintle, A.G., 1982, Thermoluminescence properties of fine grain minerals in loess: *Soil Science*, v. 134, p. 164-170.
- Wintle, A.G., 1985, Stability of the TL signal in fine grains from loess: *Nuclear Tracks*, v. 10, (in press).
- Wintle, A.G. and Brunnacker, K., 1982, Ages of volcanic tuff in Rheinhessen obtained by thermoluminescence dating of loess: *Naturwissenschaften*, v. 69, p. 181-183.
- Wintle, A.G. and Catt, J.A., 1985, Thermoluminescence dating of soils developed in Late Devensian loess at Pegwell Bay, Kent: *Journal of Soil Science*, v. 36, p. 293-298.
- Wintle, A.G. and Huntley, D.J., 1980, Thermoluminescence dating of ocean sediments: *Canadian Journal of Earth Sciences*, v. 17, p. 348-360.
- Wintle, A.G. and Huntley, D.J., 1982, Thermoluminescence dating of sediments: *Quaternary Science Reviews*, v. 1, p. 31-53.
- Wintle, A.G., Shackleton, N.J. and Lantieri, J.P., 1984, Thermoluminescence dating of periods of loess deposition and soil formation in Normandy: *Nature*, v. 310, p. 491-493.

Ms received 7 May 1985;
revision accepted 25 July 1985.